

Operating Instructions

PRT/HW-TS / PRT/HW-NTS

08/10 Revision 1

Ref: TS3EU

Contents Page

Display Symbols Explained	7
Temperature Display	8
Setting the Clock	8
Comfort Levels Explained	9-11
Setting the Hot Water Switching Times	12-13
Locking the Keypad	13
Temperature Override	14
Temperature Hold	14
Hot Water Override	15
Holiday	16
Heat On/Off	17
Clean Screen	17
Factory Reset	18
Optional Feature Setup	19-23
Wiring Diagrams	24-27

What is a programmable room thermostat ?

A programmable room thermostat is both a programmer and a room thermostat. A programmer allows you to set “On” and “Off” time periods to suit your own lifestyle. A room thermostat works by sensing the air temperature, switching on the heating when the air temperature falls below the thermostat setting, and switching it off once this set temperature has been reached.

So, a programmable room thermostat lets you choose what times you want the heating to be on, and what temperature it should reach while it is on. It will allow you to select different temperatures in your home at different times of the day (and days of the week) to meet your particular needs.

Turning a programmable room thermostat to a higher setting will not make the room heat up any faster. How quickly the room heats up depends on the design of the heating system, for example, the size of the boiler and radiators.

Neither does the setting affect how quickly the room cools

down. Turning a programmable room thermostat to a lower setting will result in the room being controlled at a lower temperature, and saves energy.

The way to set and use your programmable room thermostat is to find the lowest temperature settings that you are comfortable with at the different times you have chosen, and then leave it alone to do its job.

The best way to do this is to set low temperatures first, say 18°C, and then turn them up by one degree each day until you are comfortable with the temperatures. You won't have to adjust the thermostat further. Any adjustment above these setting will waste energy and cost you more money.

If your heating system is a boiler with radiators, there will usually be only one programmable room thermostat to control the whole house. But you can have different temperatures in individual rooms by installing thermostatic radiator valves (TRVs) on individual radiators. If you don't have TRVs, you should choose a temperature that is reasonable for the whole house. If you do have TRVs, you

can choose a slightly higher setting to make sure that even the coldest room is comfortable, then prevent any overheating in other rooms by adjusting the TRVs.

The time on the programmer must be correct. Some types have to be adjusted in spring and autumn at the changes between Greenwich Mean Time and British Summer Time.

You may be able to temporarily adjust the heating programme, for example, “Override”, “Advance” or “Boost”. These are explained in the manufacturer’s instructions.

Programmable room thermostats need a free flow of air to sense the temperature, so they must not be covered by curtains or blocked by furniture. Nearby electric fires, televisions, wall or table lamps may prevent the thermostat from working properly.

Installation Procedure

DO's

1. Do mount the thermostat at eye level.
2. Do read the instructions fully so that you get the best from our product.

DON'Ts

1. Do not install near a direct heat source as this will affect the workings of the thermostat.
2. Do not push hard on the LCD otherwise you will damage the liquid crystal display and this is not repairable.

Installation

The thermostat is designed to be flush mount, a back box of 35mm should have been sunk in the wall prior to installation.

Step 1

Carefully separate the front half of the thermostat from the back plate by placing a small flat head terminal driver in to the slots on the bottom face of the thermostat.

Step 2

Carefully unplug the ribbon connector which is plugged in to the front half of the thermostat.



Place the thermostat front half somewhere safe. Terminate the thermostat as shown in the diagrams at the back of this booklet.

Screw the thermostat back plate on to the back box

Step 3

Re-connect the thermostat ribbon cable and clip the two halves together.

Display Symbols Explained

Symbol	Description
	Heat On Icon <i>Shown when the heating is On Flashing When the optimum start is in operation.</i>
HW ON HW OFF	HW ON / HW OFF <i>Shown to indicate whether the hot water output is on or off</i>
	Frost On Icon (Heating Off) <i>Shown when the heating is switched off and is protecting against frost only</i>
	Keylock Icon <i>Shown when the keypad is locked</i>

Temperature Display

Room Temp



This is the current room temperature.

SET = This is the temperature you are trying to achieve in your home.

HW ON / HW OFF = This is the status of the hot water.

Setting The Clock

To set the clock in your thermostat, follow the steps below:

- With the thermostat turned on, press PROG
- Press Clock
- Use   to set the correct Time
- Press Day to set the correct Day
- Press Done to accept and store

Comfort Levels Explained

Comfort levels allow you to set different temperatures throughout the day. For example, you may want the home warm in the morning when you are getting ready for work, cooler during the day when the house is unoccupied and then warmer in the evening when you are home relaxing. The thermostat offers 5/2 Day Programming (4 levels for the weekday, 4 for the weekend) and 7 day Programming (4 levels for each day). See pages 19-23 for details on how to switch between these modes.

Tip ! If you don't want to use all of the comfort levels, just set the time to --.— and the thermostat will ignore this setting.

Factory Programmed Comfort Levels

The following comfort levels are programmed already, however you can change them easily.





Weekday Level

	Time	Temp
Wake	07.00	21°C
Leave	09.00	16°C
Return	16.00	21°C
Sleep	22.00	16°C

Weekend Level

	Time	Temp
Wake	09.00	21°C
Leave	22.00	16°C
Return	--.--	--°C
Sleep	--.--	--°C

Changing the Comfort Levels

- Press PROG and select Wake
- Use   to set the time for the 1st Comfort level
- Use   to set the temperature in °C
- You should now repeat for the Leave, Return & Sleep levels.
- Press Day to select the next day. In 5/2 day mode the thermostat will highlight “Sat Sun” prompting you to program the temperature levels for the weekend. In 7 day mode, the thermostat will highlight Tuesday.
- When complete, press Done to Store and Exit.

Hot Water Timings Explained

The PRTHW-TS offers an additional timed output for the hot water cylinder. The thermostat offers 5/2 Day Programming (4 levels for the weekday, 4 for the weekend) and 7 day Programming (4 levels for each day). See pages 19-23 for details on how to switch between these modes.





Factory Programmed Hot Water Times

The following hot water switching times are programmed already; however you can change them easily.

Weekday	On Time	Off Time
Wake	07.00	09.00
Leave	16.00	20.00
Return	--.--	--.--
Sleep	--.--	--.--

Weekend	Time	Temp
Wake	07.00	09.00
Leave	16.00	20.00
Return	--.--	--.--
Sleep	--.--	--.--

Changing the Hot Water Times



- Press PROG and select Timer
- You will see TIME 1 and ON flash
- Use   to set the on time for the 1st switching time
- Press Off and then use   to set the off switching time.
- You should now repeat for the Time 2-4
- Press Day to select the next day. In 5/2 day mode the thermostat will highlight “Sat Sun” prompting you to program the switching times for the weekend. In 7 day mode, the thermostat will highlight Tuesday.
- When complete, press Done to Store and Exit.

Locking the Keypad

The thermostat has a keylock facility. To enable this press the bottom right corner of the display and hold for 10 seconds.

When activated, you will see .
To cancel, repeat the steps above.

Temperature Override

Using the   keys allows you to adjust the set temperature. When you press either of these keys, you will see the word SET and the desired temperature. Press Done to accept.

This set temperature is temporary and is held until the next programmed comfort level.

Temperature Hold

The Temperature Hold function is ideal for parties or when you will be going out for a number of hours. It allows you to hold a temperature for a desired period.

- Press HOLD
- Set the desired Hold time and temperature
- Press Done
- To cancel a Hold time, reduce the time to 00.00

Hot Water Override

The thermostat has an override function for the hot water output allowing you to override the hotwater into the opposite state.

- Press Hold
- Press Timer
- If the hotwater is already On – press Off
- If the hotwater is already Off – press On

You will then see the hotwater status change and the hotwater output indication will flash to show it has been overridden from the programmed setting.

The hotwater will remain in the override state until the next programmed time. To cancel, repeat the steps above.

Holiday

The Holiday function reduces the set temperature in your home to the frost temperature setting. The thermostat will maintain this temperature for the duration of the holiday and will then automatically return to the program mode on your return.

Assume you program a holiday on Monday for 1 day, the holiday will start immediately, but the thermostat will count the next day (Tuesday) as the holiday. The thermostat will then revert back to its program at midnight Tuesday.

- Press HOLIDAY
- Enter the duration of your holiday
- Press Done
- To cancel a Holiday, reduce the Holiday time to 00 days.

During a holiday program the hot-water output is turned off.

Heat On / Off

Frost Protect Mode: Pressing the Off button once will place the thermostat in frost protect mode. In this mode, the thermostat will display the frost icon and will only turn the heating on should the room temperature drop below the set frost temperature (see pages 19-23). Should the heating be turned on whilst in frost mode, the flame symbol will be displayed. To cancel the frost protect mode, press the On button.

Thermostat Off: To turn the thermostat off completely, press and hold the Off button. The display and heating output will be turned off. To turn the thermostat back on, press the On button.

Clean Screen

Pressing Clean Screen will disable all buttons, allowing you 15 seconds to wipe the screen clean.

Factory Reset

The thermostat has a factory reset function. This will reset all settings back to their factory default.

To perform a factory reset, follow these steps:

Turn off the thermostat by pressing the off button.

Press and hold the bottom left corner of the LCD for 10 seconds. You will see all the icons appear for 2 seconds and then disappear. The thermostat has then been reset to the factory defaults.

THE FOLLOWING SETTINGS ARE OPTIONAL AND IN MOST CASES NEED NOT BE ADJUSTED

Optional Features Explained

Feature 01 – Temperature Format: This function allows you to select between °C or °F.

Feature 02 - Switching Differential: This function allows you to increase the switching differential of the thermostat. The default is 1°C which means the thermostat will switch the heating on 1°C below the set temperature and will turn it off when the set temperature is achieved. With a 2°C differential, the heating will switch on 2°C below the set temperature and will switch off when the set temperature is achieved.

Feature 03 - Frost Protect: You can set whether the thermostat will maintain the frost temperature when the thermostat display is turned off. As a default, this is enabled.

Feature 04 – Frost Protect Temperature: This is the temperature maintained when the thermostat is in frost mode. The range is 07-17°C. The default is 12°C and is suitable for almost all applications.

Feature 05 – Output Delay: To prevent rapid switching, an output delay can be entered. This can be set from 00-15 minutes. The default is 00 which means there is no delay.

Feature 06 – Communication Address: This setting is used when you have connected your thermostat to a network system. Each thermostat on the network must have a unique communication address. This can be set from 01-32.

Feature 07 – Temperature Up/Down Limit: This function allows you to limit the use of the up and down temperature arrow keys. This limit is also applicable when the thermostat is locked and so allows you to give others limited control over the heating system.

Feature 08 – Sensor Selection: This thermostat has a built in air sensor only.

Feature 09 – Floor Limit Sensor: This function is not used on this model.





Feature 10 – Optimum Start: Optimum start will bring the heating on early if needed, so the house is warm when you wake up. This means you don't need to allow any extra heat up time when programming the comfort levels. The thermostat will automatically learn the required heat up time and will adjust itself, if required, throughout the year.

Feature 11 – Rate Of Change: This is the number of minutes the thermostat has calculated it takes to raise your building 1°C. The thermostat will continue to learn the heat up time of your home and will adjust this setting to suit.

Feature 12 – 5/2 Day, 7 Day Programmable: This function allows you to switch between 5/2 day or 7 day programming. 5/2 day means you can program 4 comfort levels for the weekday and 4 different levels for the weekend. 7 day programming allows you to program 4 temperature levels for each day of the week.

Adjusting the Optional Settings

To adjust the settings, follow these steps:

- With the thermostat turned on
- Press PROG
- Press SETUP
- Use the   at the top of the screen to select the feature number (shown on page 23) and then use the   keys in the centre adjust the setting.
- Press Done to accept and Store

Re-calibrating the thermostat

If you need to re-calibrate the thermostat follow these instructions:

1. Press and hold the OFF button to turn the thermostat off.
2. Press and hold the ON button until the temperature appears on the screen.
3. Use the up/down buttons to set the new temperature.
4. Press DONE to accept.
5. Press the ON button once to turn the thermostat back on.

Feature Table

Feature	Description	Setting
01	Temperature Format	00=°C 01=°F
02	Switching Differential	0.5=0.5°C - 3.0=3°C 1.0°C = Default
03	Frost Protect	00 = Disabled 01=Enabled (01=Default)
04	Frost Temp	07-17°C (12=Default)
05	Output Delay	Enter value 00-15 minutes (00=Default)
06	Comms #	Enter number 01-32
07	Temp Limit	00 - 10°C
10	Optimum Start	00=Disabled (Default) 01=01hr 02=02hr 03=03hr
11	Rate of Change	For information only
12	Program Mode	00=5/2 Day (Default) 01=7 Day

Heatmiser PRT/HW-TS Model

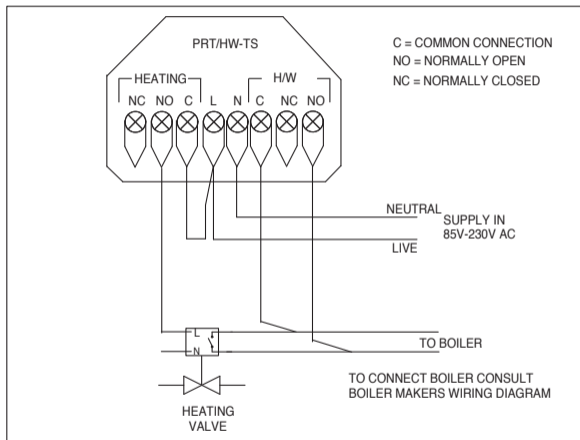

Heatmiser PRT/HW-TS Model

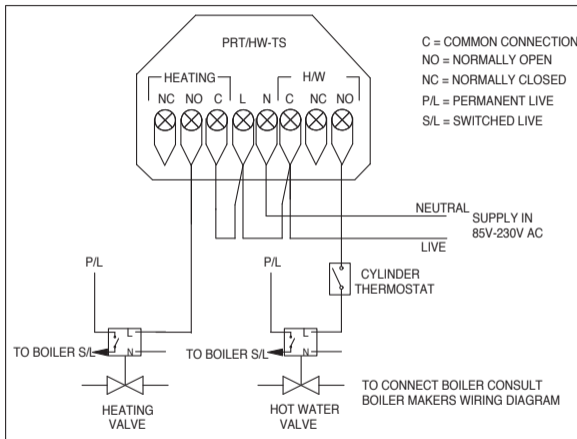

Heatmiser PRT/HW-TS Model

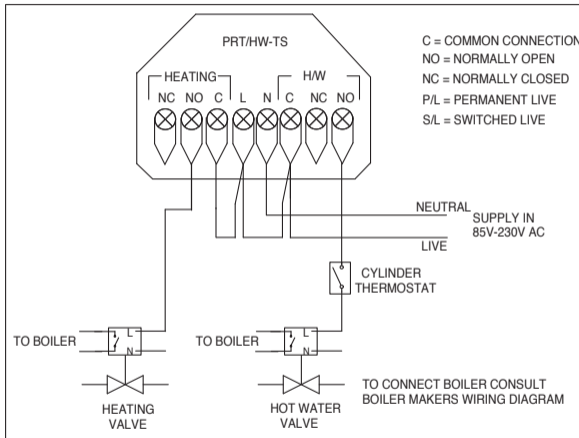

Heatmiser PRT/HW-NTS Model

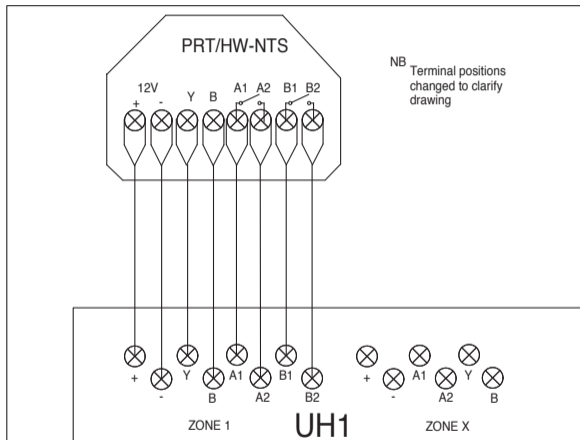



Certification mark